

OUTLINE DIMENSIONS

MOTOR TYPE:

3-PHASE INDUCTION MOTOR

FRAME NO. 284TC

Totally Enclosed Fan Cooled Type, Squirrel-cage Rotor.

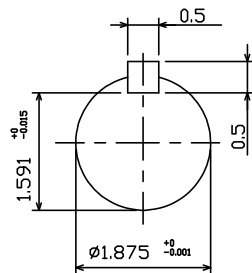
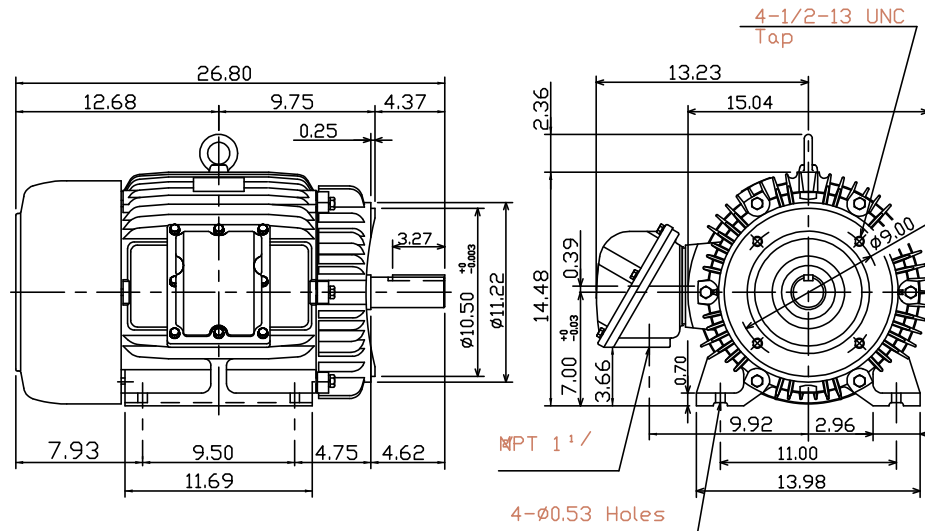

Note:  
1. Explosion proof:  
Class I Group D and  
Class II Group E.F.G.

**BROOK CROMPTON**

DWG NO.